

# Avances en interfase web para sistemas embebidos utilizando tecnologías ESP

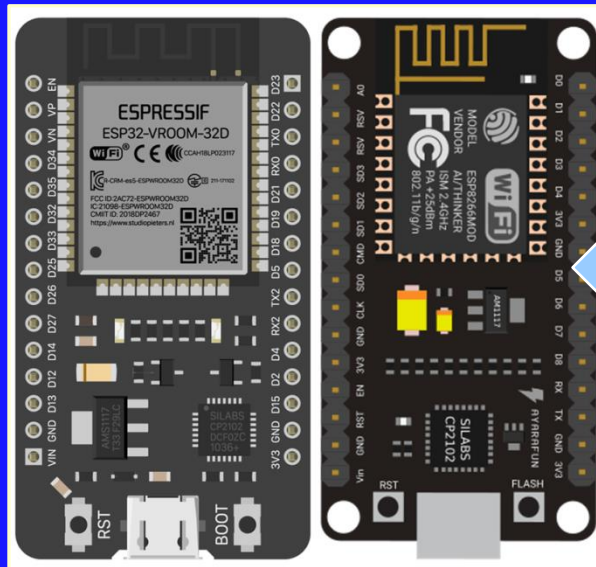

Parte II – Aplicaciones - Ing. Esp. Néstor Cortez  
Instituto de Tecnología Aplicada (ITA-UARG)

JORNADAS DE INFORMÁTICA 2022 – UNPA /UARG  
04 de noviembre de 2022

## EDUCIAA



## Nodemcu ESP32

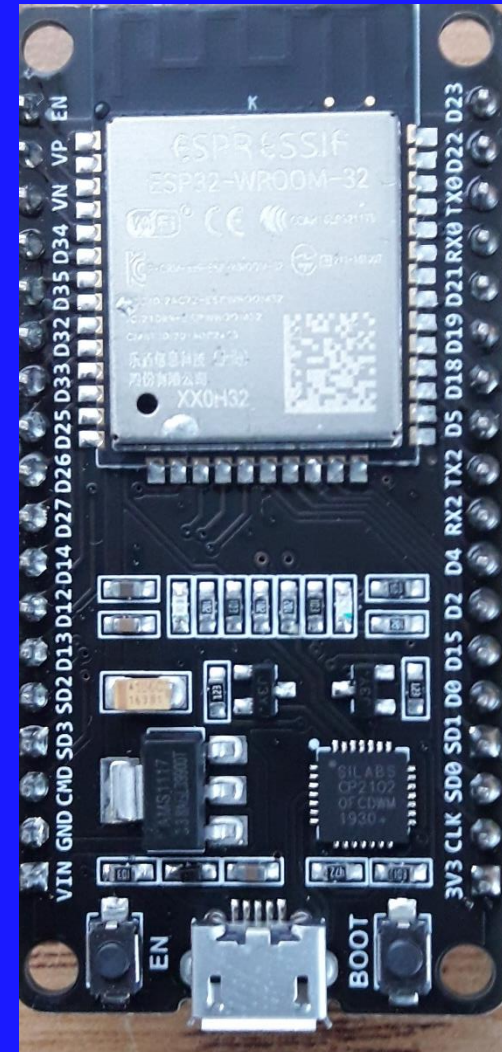

## CONTENIDOS :

- EDU CIAA y CIAA. Conexión con el mundo exterior
- Comparación con PLC / Ladder, accionamientos comunes
- Programación. Ejemplos concretos
- Accionamiento de motor eléctrico EDU – CIAA + Display alfanumérico
- Prototipo de uso de poncho para accionamiento de motor eléctrico en inversión de giro.
- Interfaz Web - módulos ESP (Aplicación)
- Conexión ESP - Sistema Embebido



# EDU-CIAA-NXP



## En la placa

2 puertos micro-USB (uno para aplicaciones y debugging, otro para alimentación).

6 salidas digitales, 3 mediante un led RGB (LED\_R, LED\_G y LED\_B) y 3 leds con leds normales (LED\_1 a LED\_3).

4 entradas digitales con pulsadores (TEC\_1 a TEC\_4).

1 puerto de comunicaciones RS 485 con bornera.

## Conector de expansión CON0

3 entradas analógicas (ADC0 a ADC2).

1 salida analógica (DAC0).

1 conexión para un teclado de 3x4.

12 pines genéricos de I/O.

## Conector de expansión CON1

1 puerto Ethernet.

1 puerto CAN.

1 puerto SPI.

1 puerto I2C.

12 pines genéricos de I/O.

# CIAA-NXP

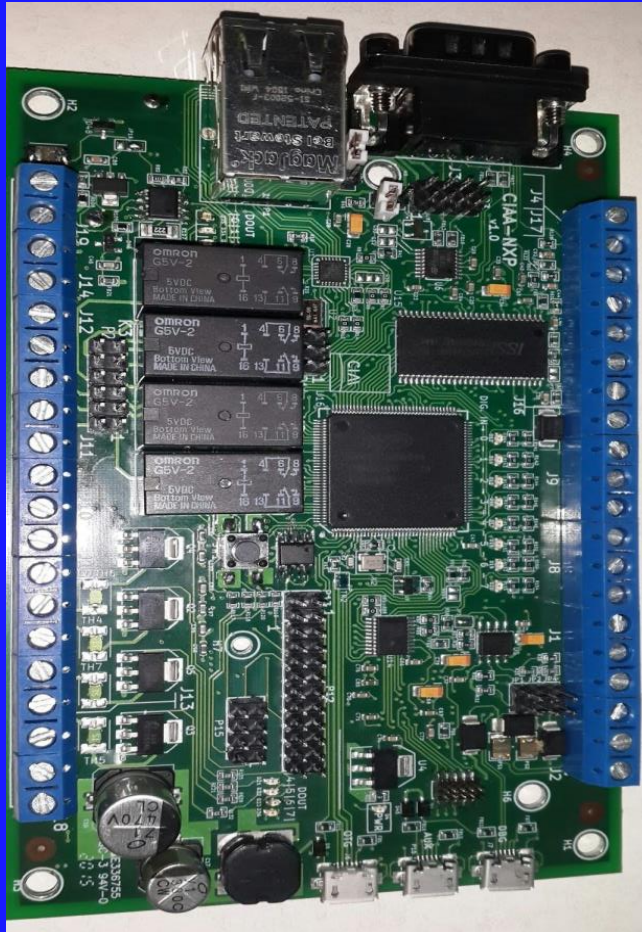

## Fuente de alimentación

Fuente de 12/24VDC a 5VDC y 3.3VDC

## Interfaces de comunicación

- Ethernet con soporte PoE (requiere módulo de alimentación PoE) ([detalles técnicos](#))
- USB On-The-Go
- USB Device Auxiliar
- RS232 ([detalles técnicos](#))
- RS485

## Entradas/Salidas

- 8 entradas digitales optoacopladas
- 4 entradas analógicas configurables por jumper 0-10V o 0-20mA ([detalles técnicos](#))
- 4 salidas open-drain de 24V, 1A
- 4 salidas a relé 24V, 2A ([detalles técnicos](#))
- 1 salida analógica configurable por jumper 0-10V o 0-20mA ([detalles técnicos](#))

# ¿QUÉ ES UN P.L.C?



ES UN SISTEMA ELECTRÓNICO PROGRAMABLE DISEÑADO PARA CONTROLAR DIFERENTES TIPOS DE MÁQUINAS O PROCESOS LOGICOS O SECUENCIALES EN UN ENTORNO INDUSTRIAL

# ¿Dónde se utiliza?

Principalmente en industrias para automatización y control de procesos.





# También en...



Domótica  
Semáforos  
Barreras y Señalización Automática



Adquirir datos del proceso por medio de sensores conectados eléctricamente a sus entradas digitales y analógicas.



Actuar sobre el proceso mediante sus salidas digitales y analógicas conectadas eléctricamente a actuadores.

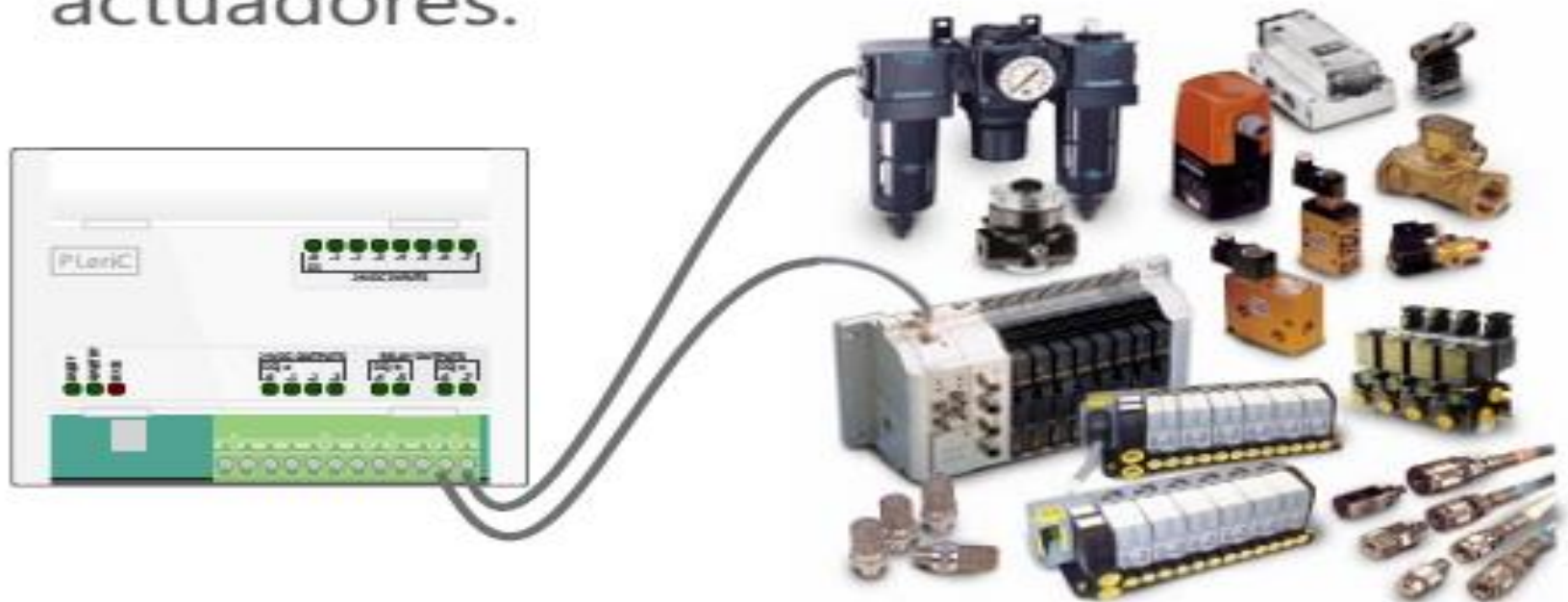

# Comunicarse con otros sistemas externos.

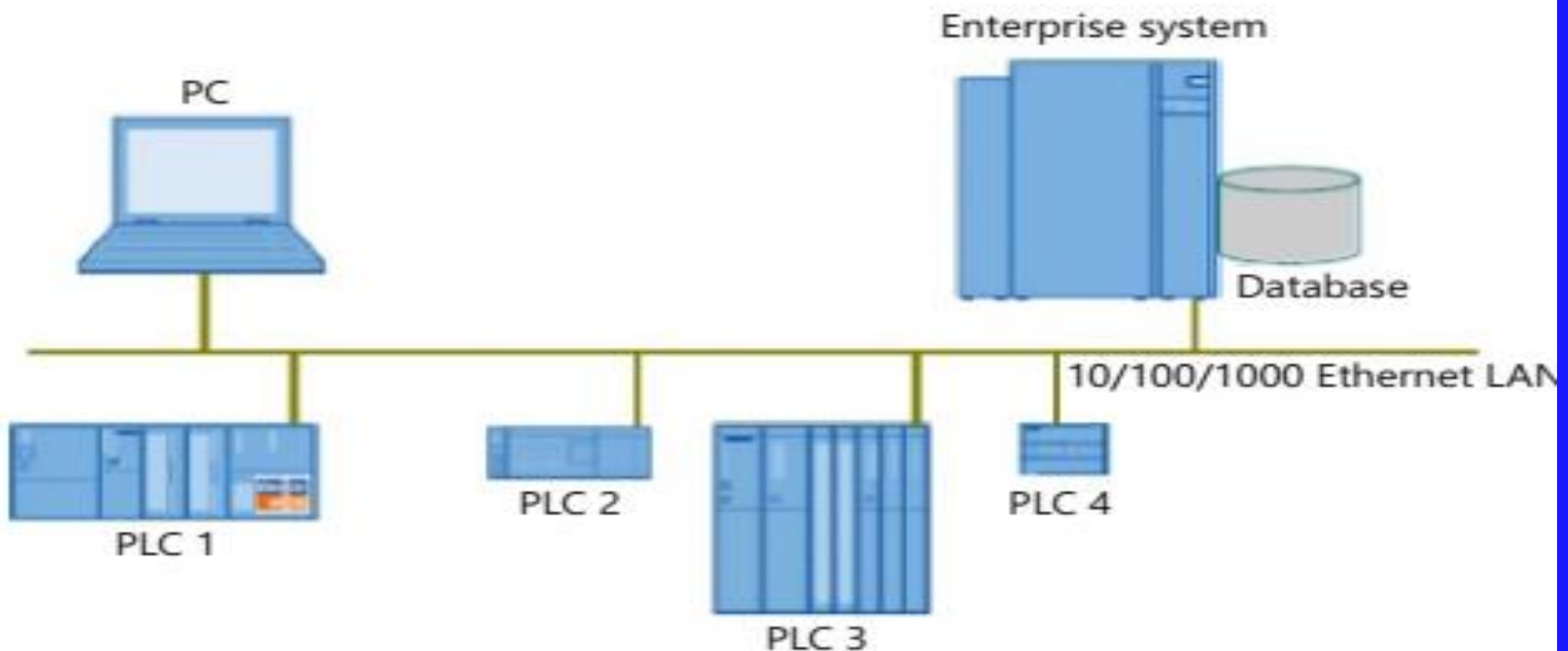

# Lenguajes de programación

IL

```
LD    A
ANDN B
ST    C
```

ST

```
C = A AND NOT B
```

FBD

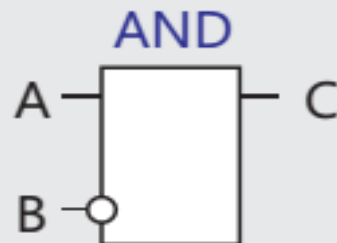

LD

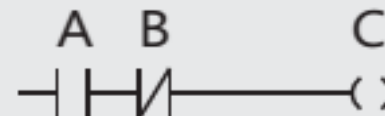



# Programación LADDER



para usuarios

# Origen de IDE4PLC

Software desarrollado originalmente como implementación de referencia de la tesis de Ingeniería en Automatización y Control Industrial del Ing. Eric Pernía:

- “Diseño de software y hardware de un controlador lógico programable (PLC) y su entorno de programación”

Disponible en la web de IDE4PLC.

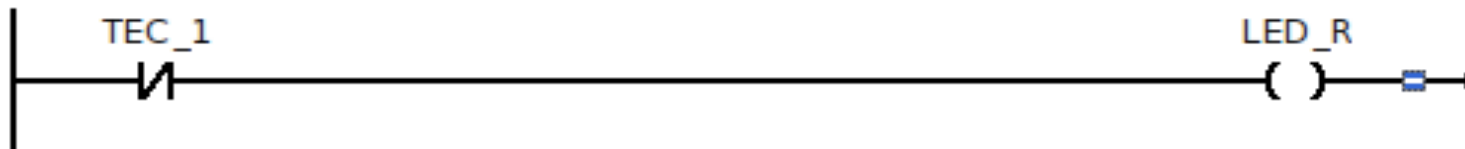
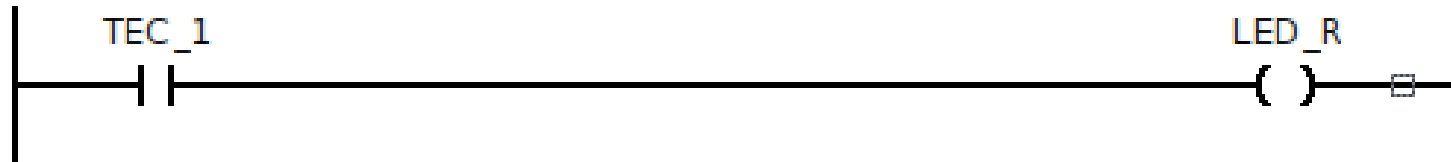

# Ejemplos: Circuito con auto retención

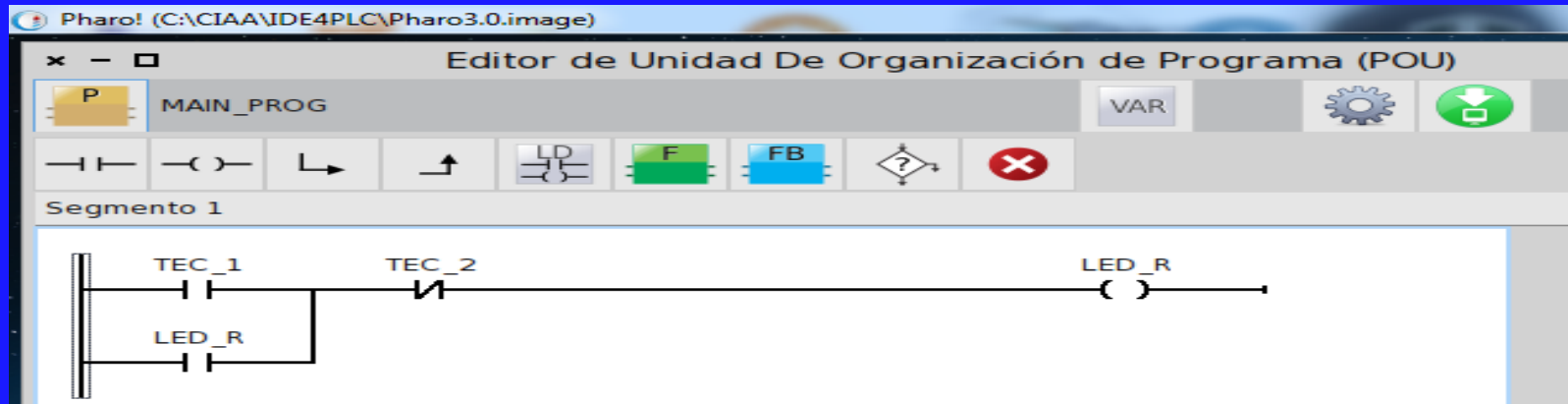

# Circuito contador

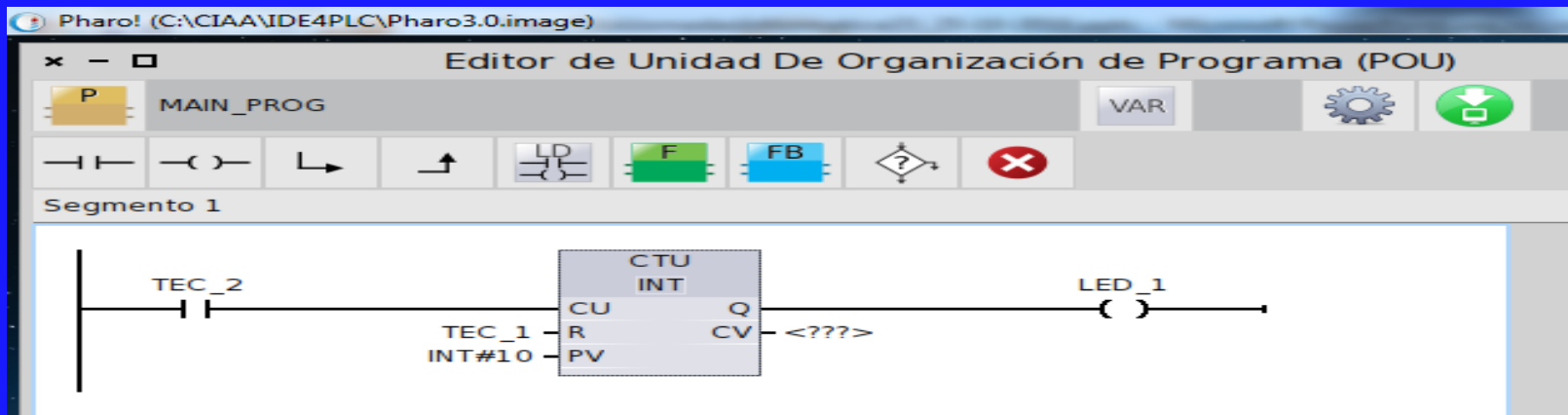



# Ejemplos: Temporizadores

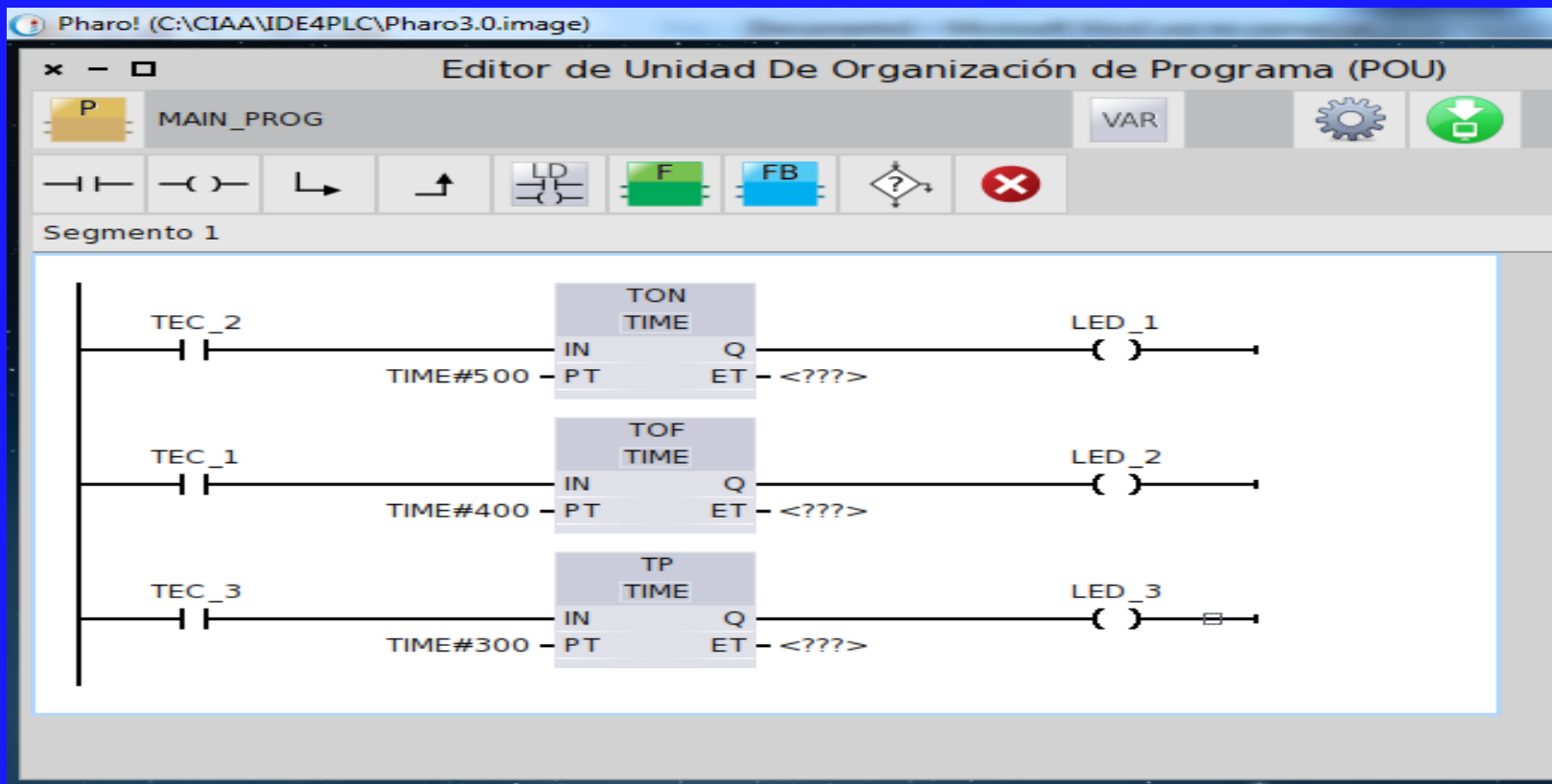

# SOFTWARE DE SECUENCIA DE LUCES CONTENIDO EN EDU CIAA Y CIAA – NXP

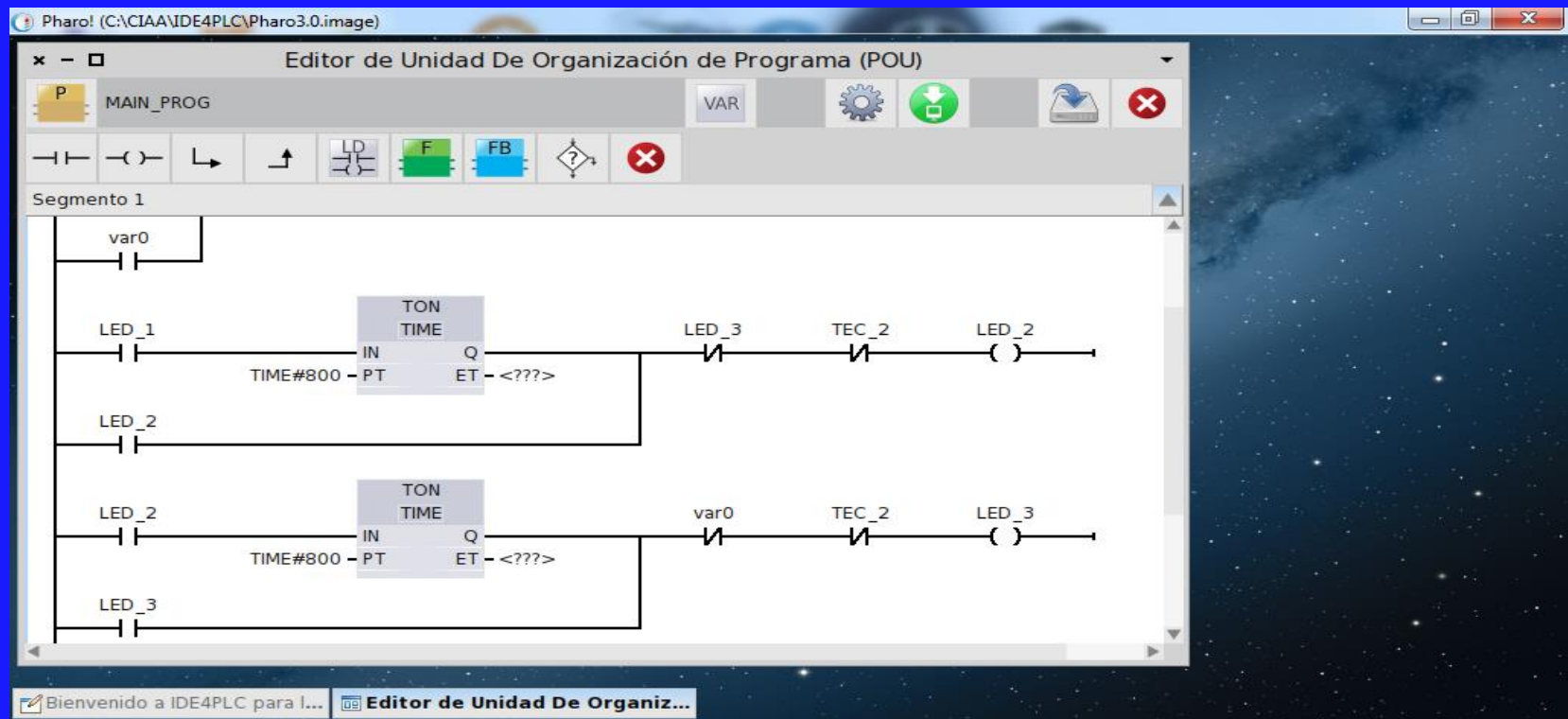



SISTEMAS  
EMBEBIDOS  
2021



Computadora Industrial  
Abierta Argentina  
Desarrollo colectivo



# PROGRAMACIÓN EN C DE LA EDU CIAA

- BARE METAL (sin sistema operativo)



SISTEMAS  
EMBEBIDOS  
2021



Computadora Industrial  
Abierta Argentina  
Desarrollo colectivo



C/C++ - Firmware/projects/drivers\_bm/src/ind.c - Eclipse

File Edit Source Refactor Navigate Search Project Run Window Help

Project Explorer

- 14\_Aquisicion\_Transmision2
- 15\_MotorLavarropa
- 16\_Motor\_Tecla
- 17\_lcd
- 17\_usolcd
- 18\_MotorTecla\_lcd
- 19\_inout\_lcd-poncho
- 20\_lcd-poncho-sensores
- blinking
- drivers\_bm
- EJ\_1\_BM
- EJ\_2\_BM
- EJ\_7\_BM
- ej01\_sapi\_switches\_leds
- ej04\_sapi\_sequences
- ej08\_sapi\_adc\_dac
- ej09\_sapi\_rtc
- ej12\_sapi\_hmc5883l
- lcd
- myproject
- Plantilla\_1\_blinking\_baremetal
- sapi\_bm
- sAPI\_LCD\_MAG
- 1\_blinking\_baremetal.rar
- 19\_inout\_lcd-poncho.rar
- drivers\_bm.rar
- lcd.rar
- RemoteSystemsTempFiles
- circle.yml
- Makefile
- Makefile.config
- Makefile.mine
- readme.md

inout.c | inout.h | ind.c | ind.h

```

70 #error CPU_shall_be_defined
71 #endif
72 #if (lpc4337 == CPU)
73 #include "chip.h"
74 #elif (mk60fx512vlq15 == CPU)
75 #else
76 #endif
77 #include "ind.h"
78 #include "stdint.h"
79
80
81 /*-----[macros and definitions]-----*/
82 #define IND_1PAQUETE 1 /*puerto o paquete 1 para COL0 */
83 #define IND_4PAQUETE 4 /*puerto o paquete 4 para F0,F1,F2 y F3 */
84 #define IND_7PAQUETE 7 /*puerto o paquete 7 para COL1 Y COL2 */
85
86 #define IND0_PIN 4 /*PINES DEL PAQUETE 0 PUERTO 7 - COL1*/
87 #define IND1_PIN 5 /*PINES DEL PAQUETE 0 PUERTO 7 - COL2*/
88 #define IND2_PIN 0 /*PINES DEL PAQUETE 0 PUERTO 4 - F0*/
89 #define IND3_PIN 1 /*PINES DEL PAQUETE 0 PUERTO 4 - F1*/
90 #define IND4_PIN 5 /*PINES DEL PAQUETE 0 PUERTO 1 - COL0*/
91 #define IND5_PIN 2 /*PINES DEL PAQUETE 0 PUERTO 4 - F2*/
92 #define IND6_PIN 3 /*PINES DEL PAQUETE 0 PUERTO 4 - F3*/
93
94
95 #define IND0_BIT 12 /* NRO DE BIT Q ACOMPAÑA AL GPIO3*/
96 #define IND1_BIT 13 /* NRO DE BIT Q ACOMPAÑA AL GPIO3*/
97 #define IND2_BIT 0 /* NRO DE BIT Q ACOMPAÑA AL GPIO2*/

```

Out... Mak... Tas...

- chip.h
- ind.h
- stdint.h
- # IND\_1PAQUETE
- # IND\_4PAQUETE
- # IND\_7PAQUETE
- # IND0\_PIN
- # IND1\_PIN
- # IND2\_PIN
- # IND3\_PIN
- # IND4\_PIN
- # IND5\_PIN
- # IND6\_PIN
- # IND0\_BIT
- # IND1\_BIT
- # IND2\_BIT
- # IND3\_BIT
- # IND4\_BIT
- # IND5\_BIT
- # IND6\_BIT
- # NUMGPIO\_IND4
- # NUMGPIO\_IND235Y6
- # NUMGPIO\_IND0Y1

Problems Tasks Console Properties

4 errors, 11 warnings, 0 others

Description	Resource	Path	Location	Type
> Errors (4 items)				
> Warnings (11 items)				





SISTEMAS  
EMBEBIDOS  
2021



**Computadora Industrial  
Abierta Argentina**  
Desarrollo colectivo



# APLICACIONES

# Ejemplo de aplicación. Inversor de giro motor monofásico

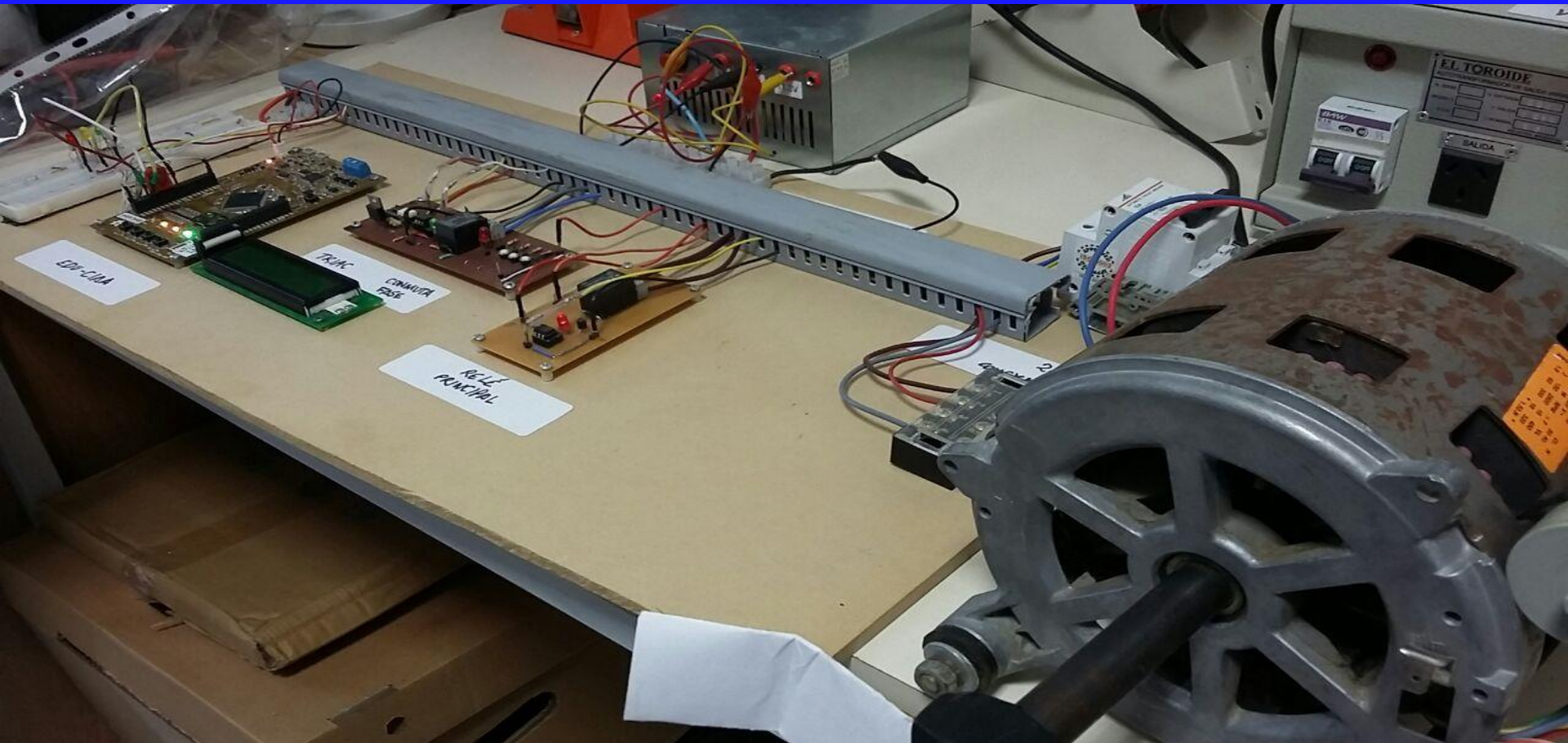

# Drivers de inversión de giro

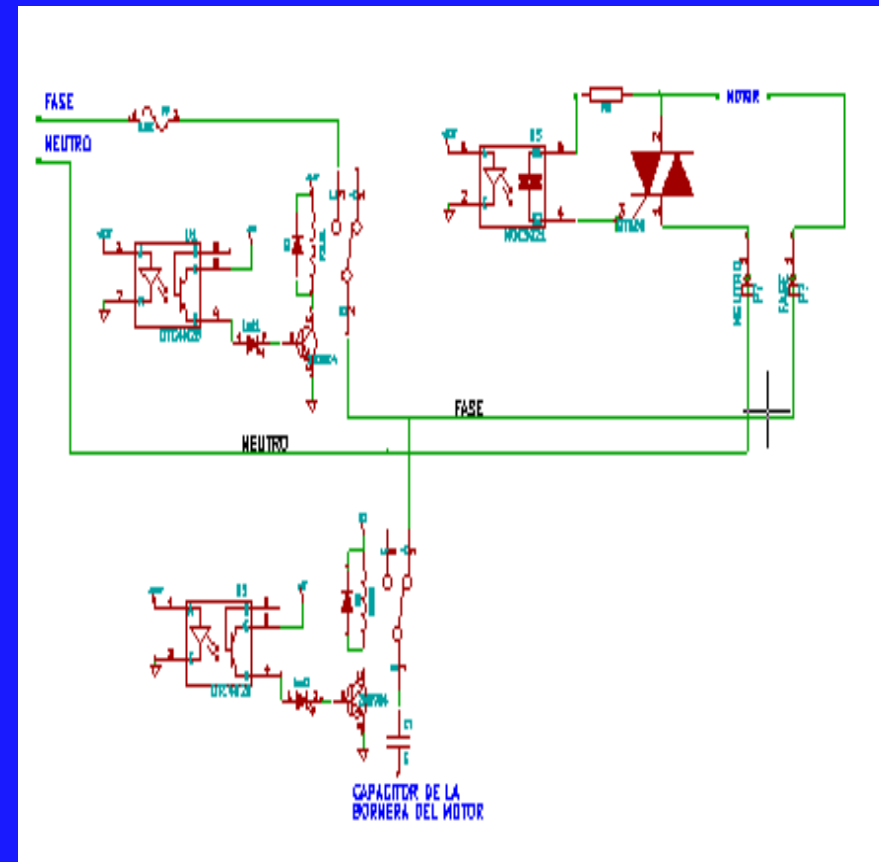
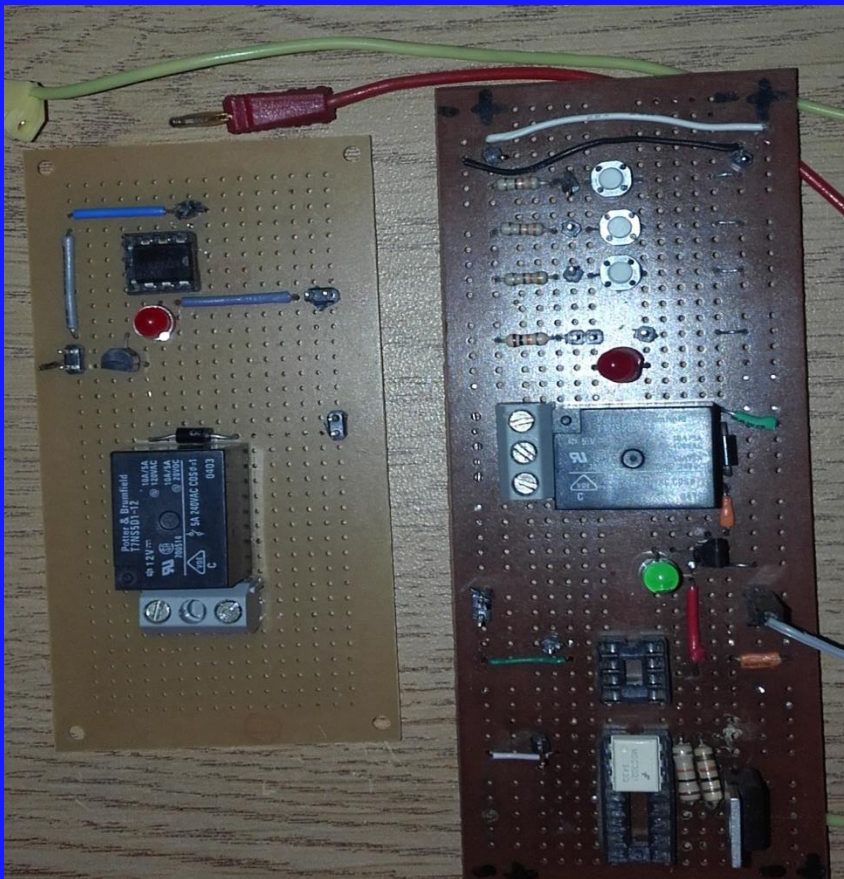



# Tablero del inversor de giro

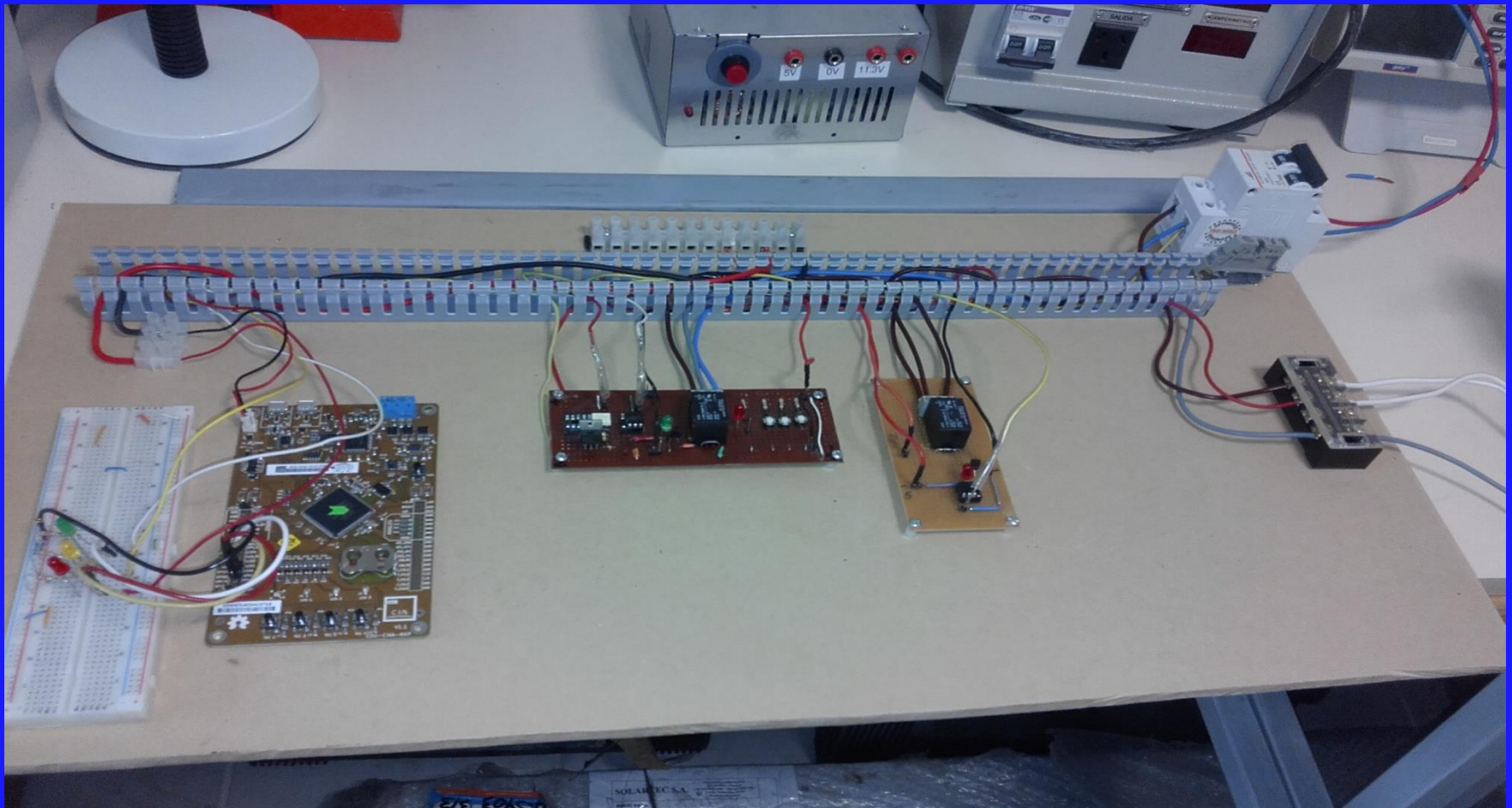

# Tablero del inversor de giro - LCD

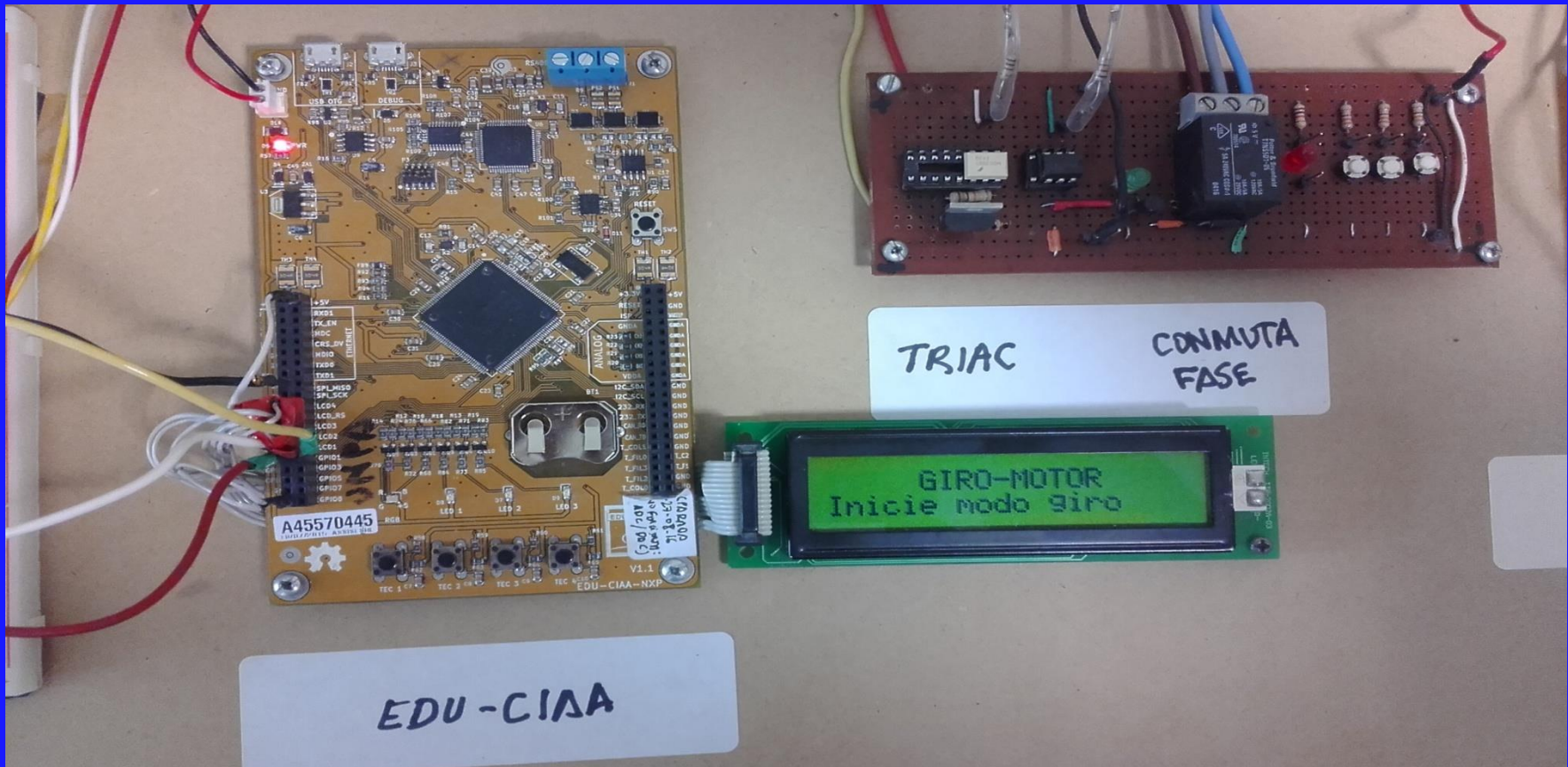



# Esquema de conexión de la CIAA - Secuencia

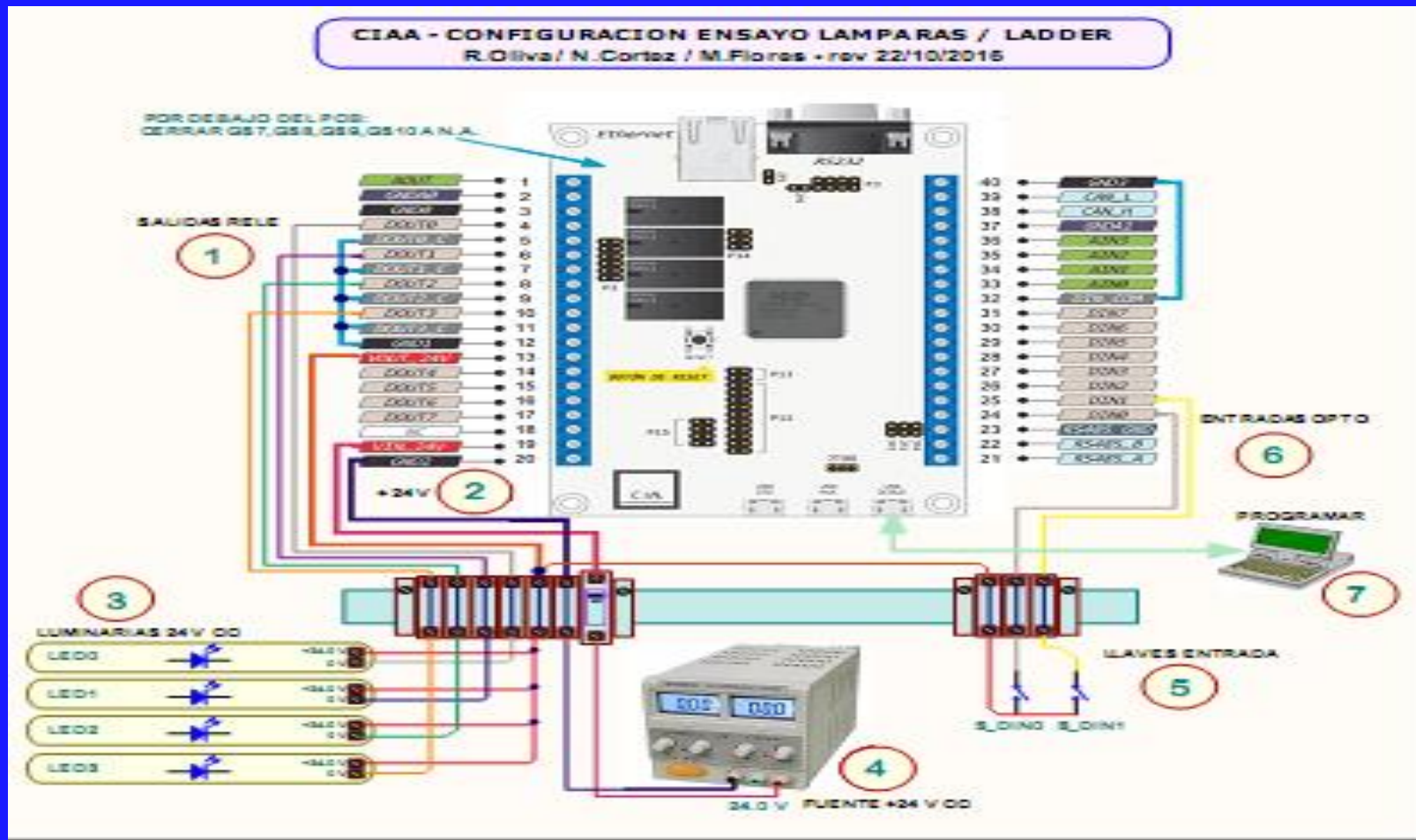

# Conexión de la CIAA para control

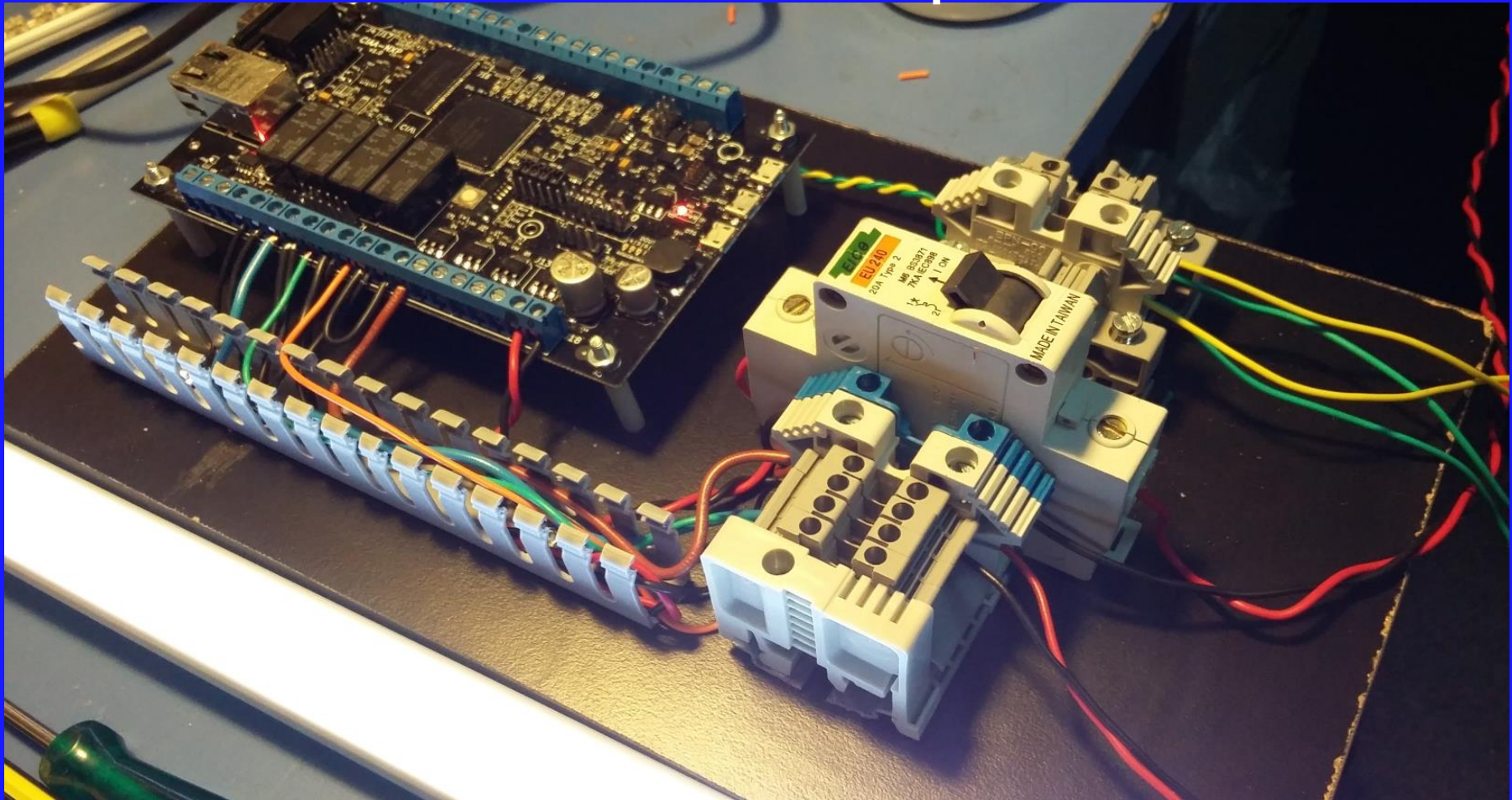



SISTEMAS  
EMBEBIDOS  
2021



Computadora Industrial  
Abierta Argentina  
Desarrollo colectivo



# MÓDULOS CONECTABLES A LA EDU CIAA

## -PONCHOS-



# PONCHOS PARA LA EDU CIAA

Llamamos “Ponchos” a los módulos conectables sobre alguna CIAA que extienden la funcionalidad de la misma agregando el hardware necesario para distintas aplicaciones.



# PONCHO P.L.C

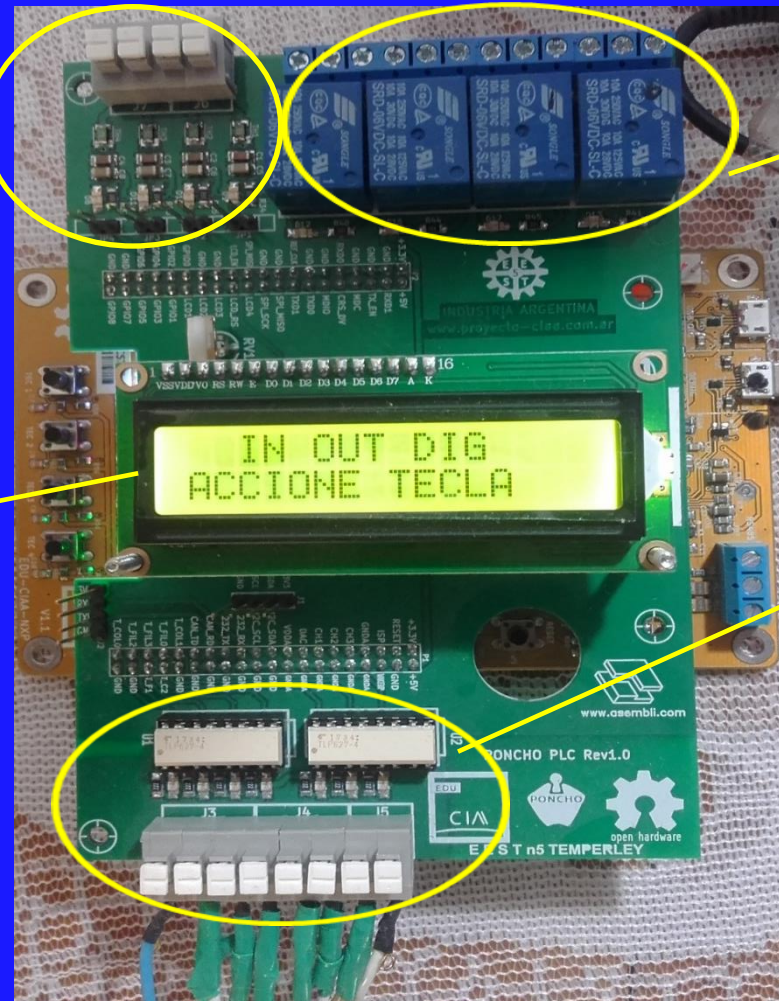

SALIDAS DIGITALES  
RELÉ

SALIDAS DIGITALES  
TRANSISTOR

ENTRADAS DIGITALES  
OPTOACOPLADAS

DISPLAY LCD



# ENTRADAS - SALIDAS - DIGITALES

## SENSORES CAPACITIVOS - INDUCTIVOS



## SENSOR ÓPTICO RETROREFLECTIVO

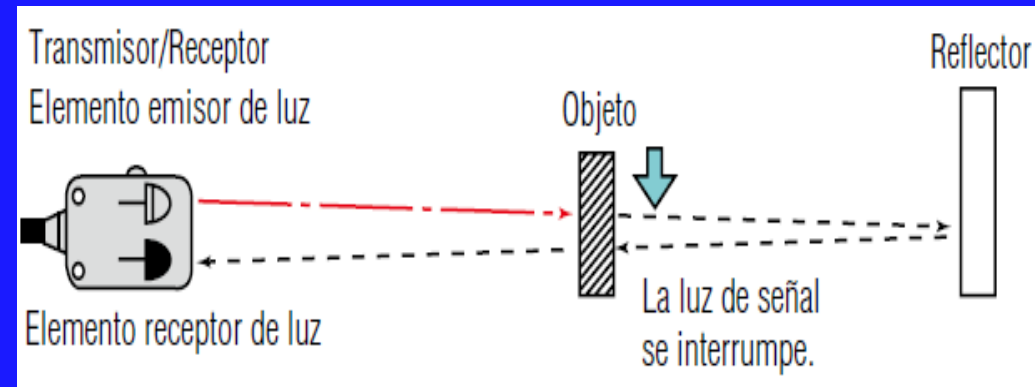

## SALIDA RELÉ

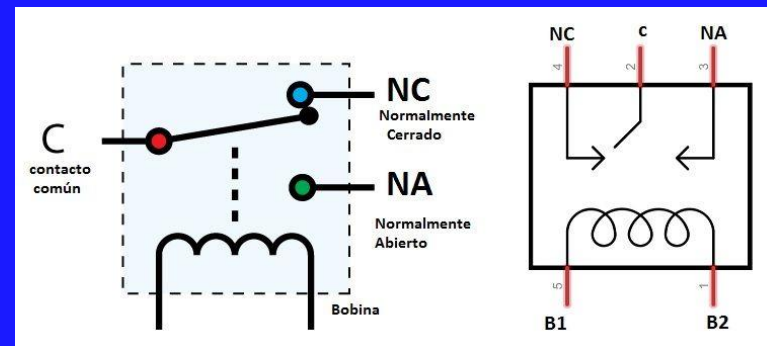

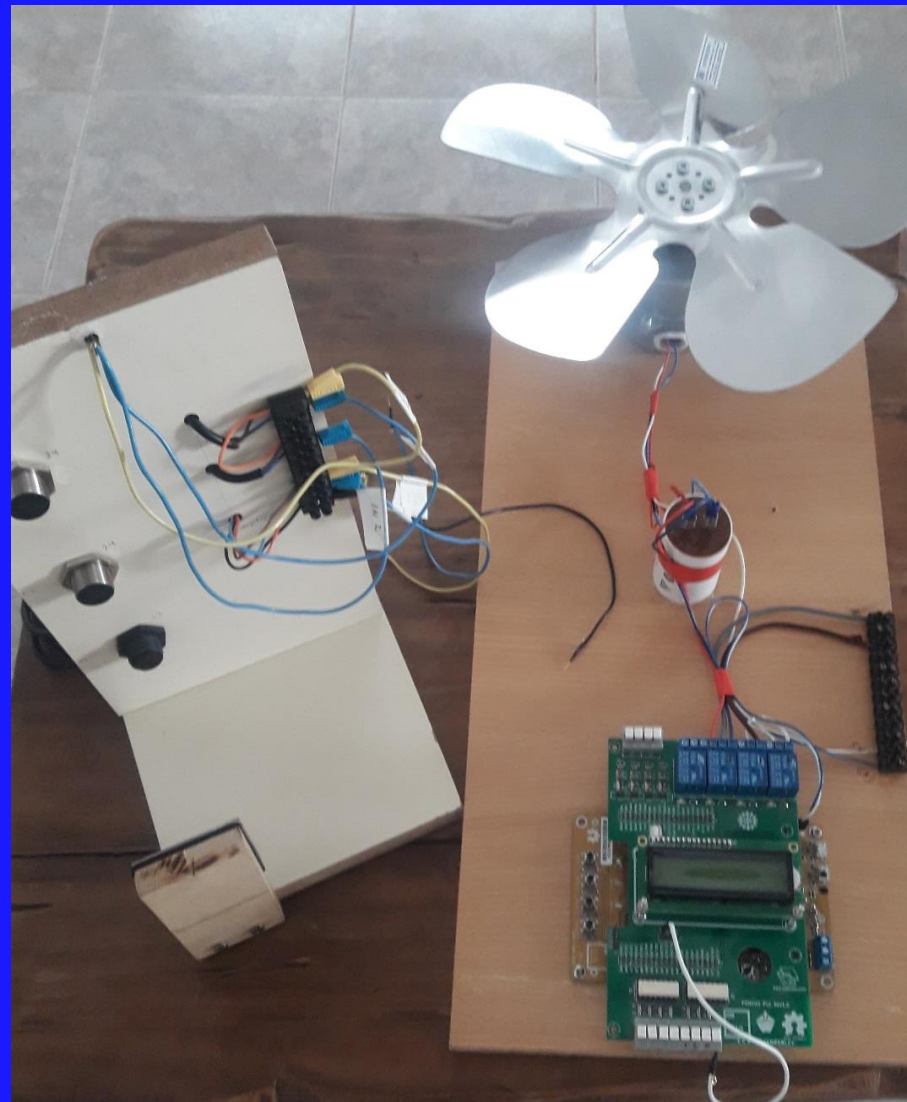
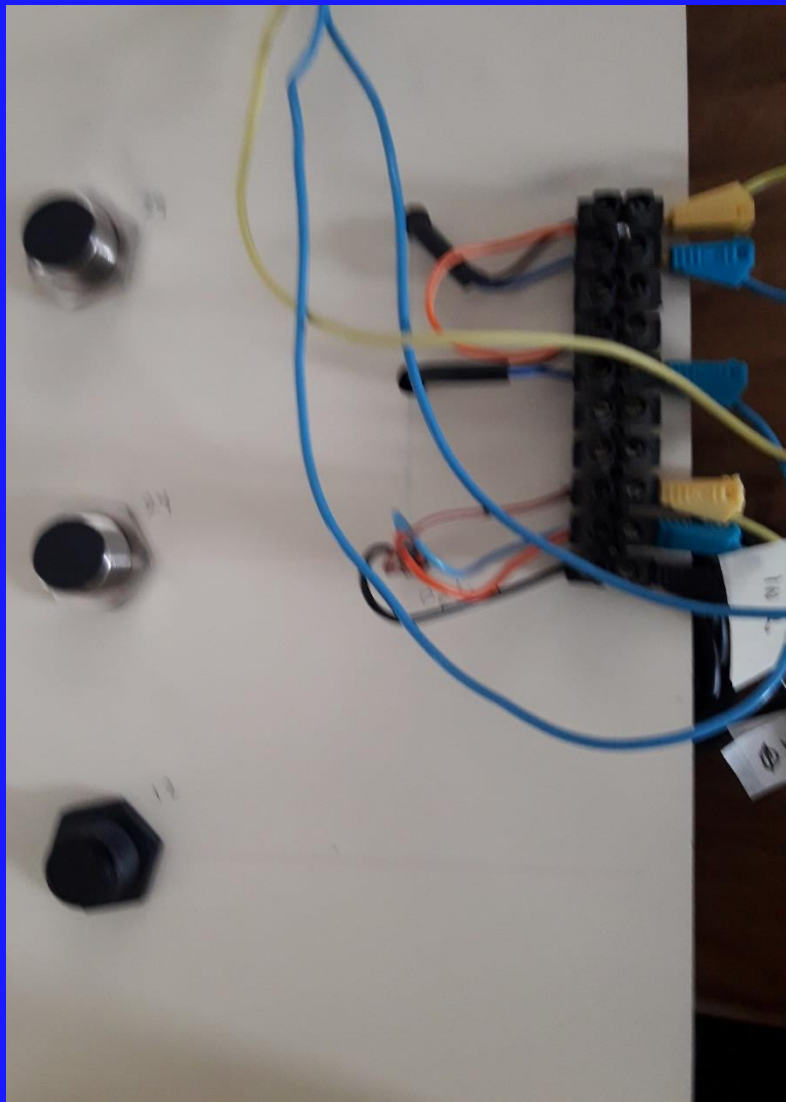

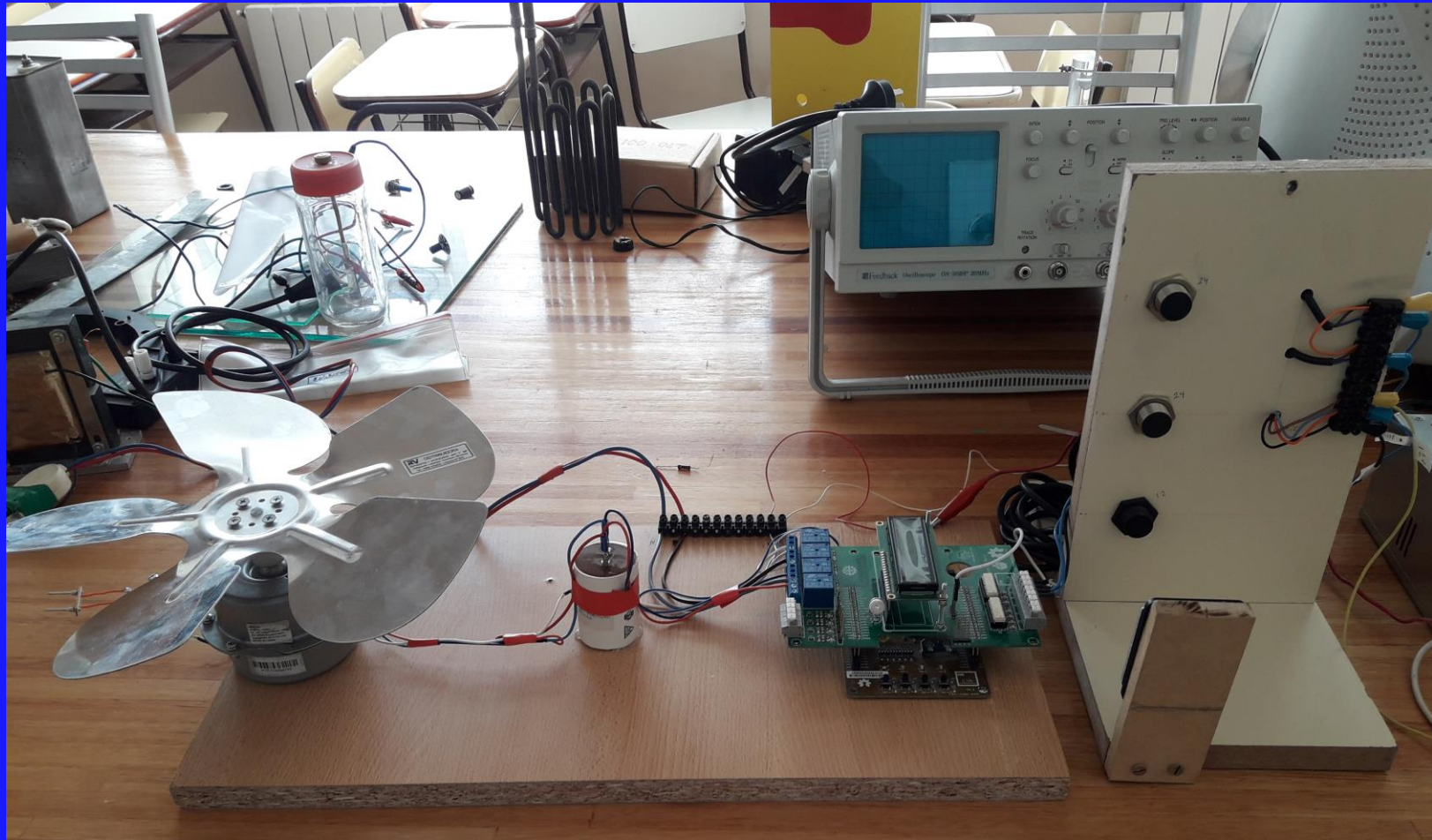



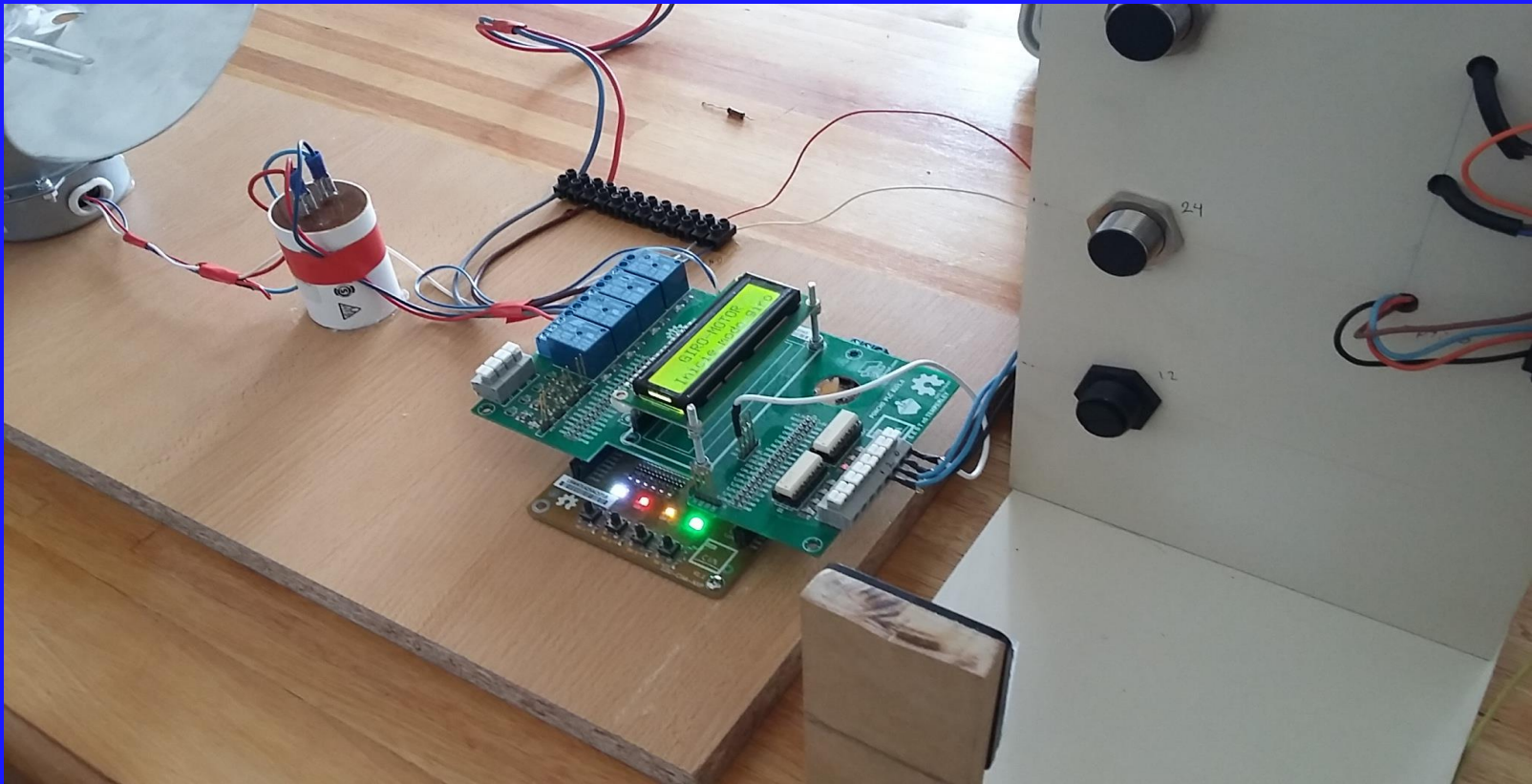

<https://www.youtube.com/watch?v=Jr6z9elGYnc>



# Node MCU ESP 32



## ESP 32

- Microprocesador de 32 – bits
- Interfaz serie-USB y regulador de voltaje
- Comunicación inalámbrica Wifi – Bluetooth
- Interfases periféricas: I2C, SPI, CAN, PWM, etc
- Entradas digitales y analógicas de 12 bit
- Salidas Analógicas PWM
- Controlador SD/MMC
- Controlador remoto infrarrojo
- Algunos modelos tienen integrados: Cámaras, pantallas Oled, Módulos LoRa, etc.

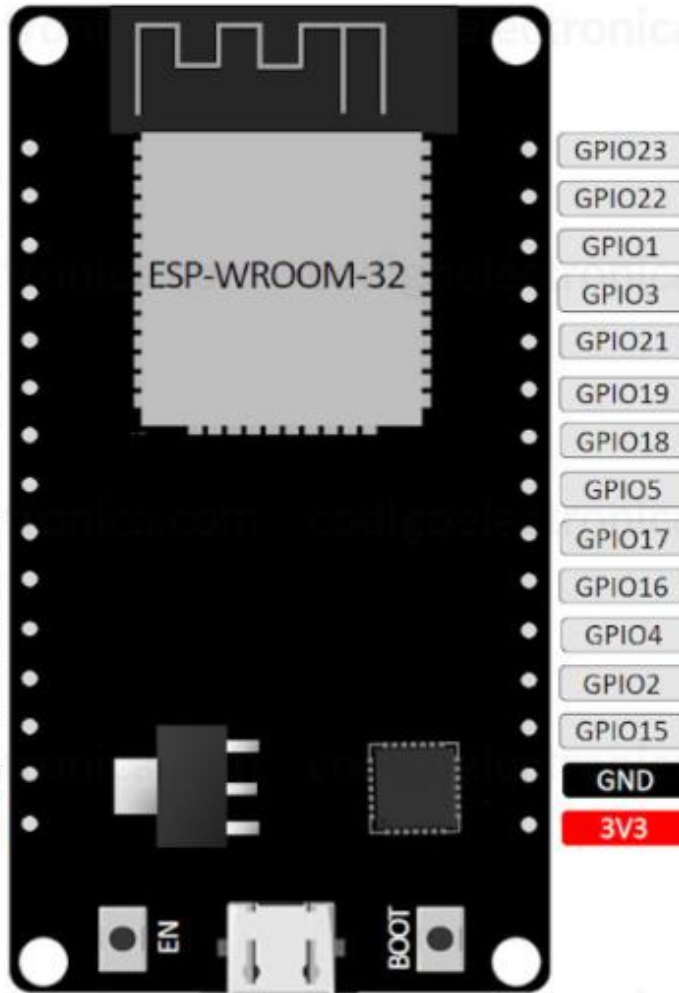

# ESP32 MCU - DHT 22

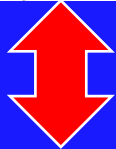
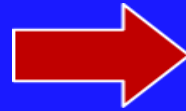
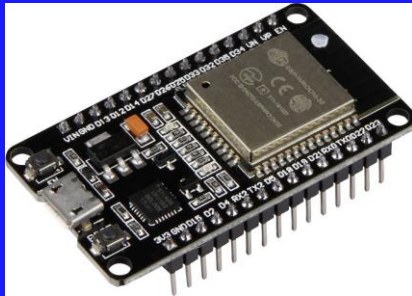

Sensor  
DHT22

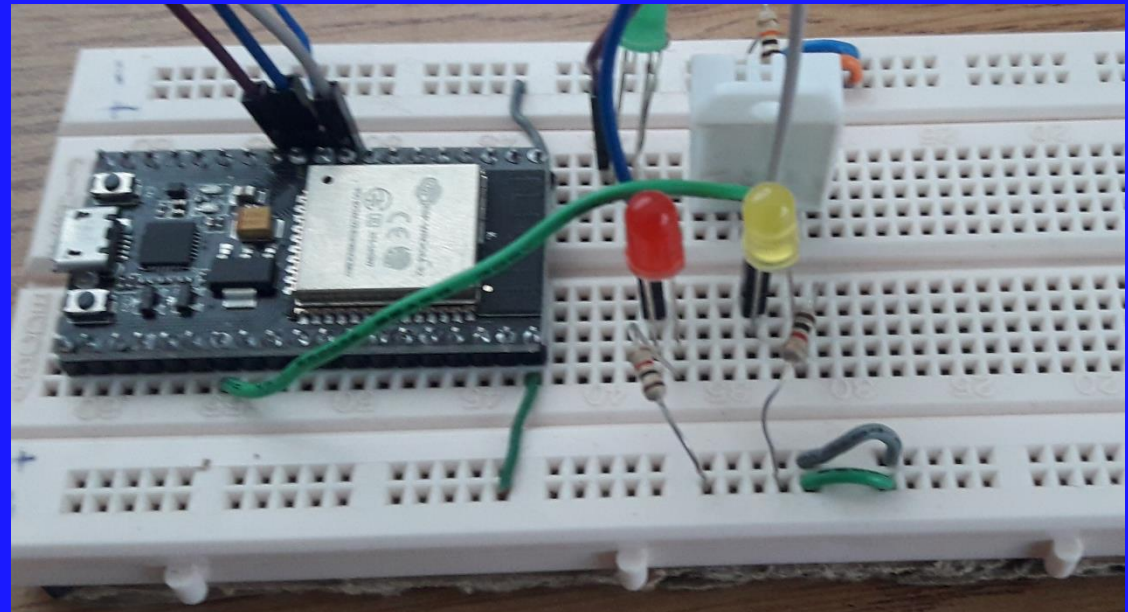

```

1 #include "ThingSpeak.h" // agregado para comunicación thingspeak
2 #include "WiFi.h" // agregado para comunicación thingspeak
3 #include "DHT.h"
4
5
6 #define DHTPIN 4 // defino el pin donde estará conectado el
7 #define DHTTYPE DHT22 // defino el tipo de sensor
8
9
10 const char* ssid = "xxxxxxxxx"; // agregado para comunicac
11 const char* password = "xxxxxxxxx"; // agregado para comuni
12
13 unsigned long channelID =144965; // agregado para comun
14 const char* WriteAPIKey = "1ZLADKSNDS30OU"; // agregado para con
15

```

```

.....WIFI CONECTADO!
Temperatura DHT22: 23.00 °C.
Humedad DHT22: 36.10 %.
-----
datos enviados a Write APIKey
Temperatura DHT22: 23.10 °C.
Humedad DHT22: 35.90 %.
-----
datos enviados a Write APIKey
Temperatura DHT22: 23.50 °C.
Humedad DHT22: 35.90 %.
-----
datos enviados a Write APIKey

```

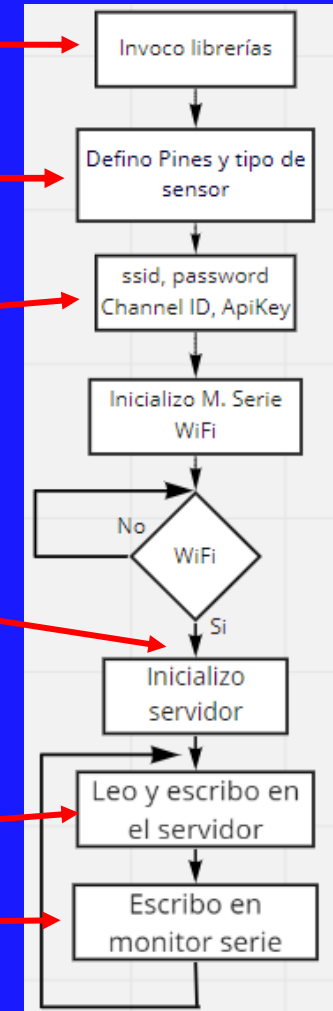



ThingSpeak™ Canales Aplicaciones Apoyo ▾

Uso comercial Cómo comprar

# ThingSpeak para proyectos de IoT

Recopilación de datos en la nube con análisis de datos avanzado usando MATLAB

[Empiece gratis](#) [Aprende más](#)

## ThingSpeak para estudiantes y educadores

Implemente proyectos de investigación de IoT rápidamente con herramientas integradas de análisis de datos de MATLAB y recopilación de datos de sensores en tiempo real

## Acerca de ThingSpeak

ThingSpeak es un servicio de plataforma de análisis de IoT que le permite agregar, visualizar y analizar flujos de datos en vivo en la nube. Puede enviar datos a ThingSpeak desde sus dispositivos, crear una visualización instantánea de datos en vivo y enviar alertas.



Recoger

Envíe los datos del sensor de forma privada a la nube.



Analizar

Analice y visualice sus datos con MATLAB.



actuar

Desencadena una reacción.



SISTEMAS EMBEBIDOS 2021



Computadora Industrial Abierta Argentina Desarrollo colectivo



ThingSpeak™

Channels

Apps

Support

Commercial Use

How to Buy



To use ThingSpeak, you must sign in with your existing MathWorks account or create a new one.

Non-commercial users may use ThingSpeak for free. Free accounts offer limits on certain functionality. Commercial users are eligible for a time-limited free evaluation. To get full access to the MATLAB analysis features on ThingSpeak, log in to ThingSpeak using the email address associated with your university or organization.

To send data faster to ThingSpeak or to send more data from more devices, consider the [paid license options](#) for commercial, academic, home and student usage.



Email

No account? [Create one!](#)

By signing in you agree to our [privacy policy](#).

Next

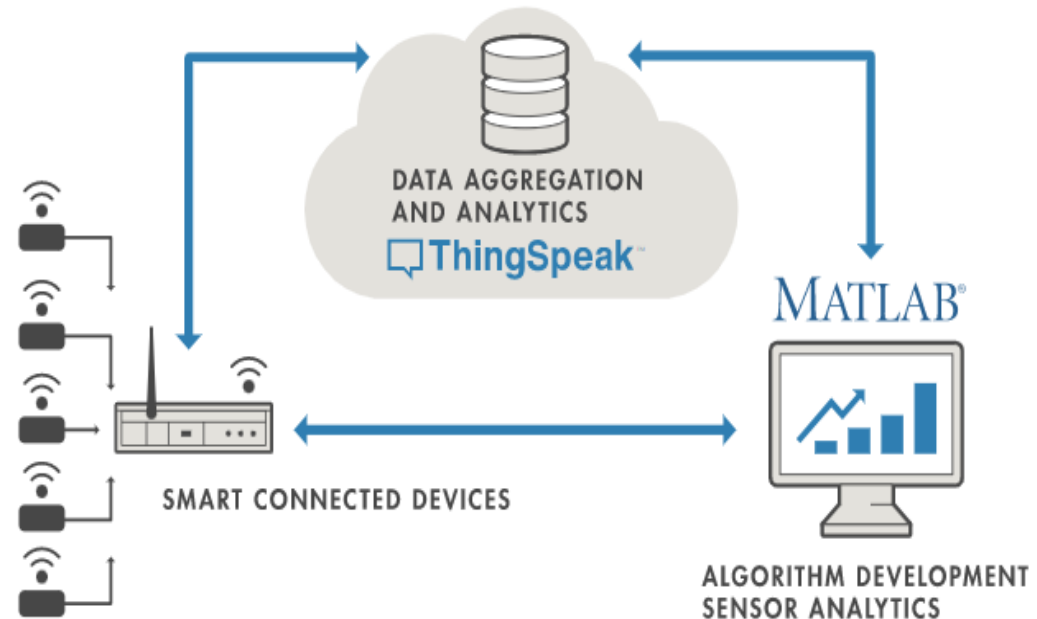





SISTEMAS  
EMBEBIDOS  
2021



Computadora Industrial  
Abierta Argentina  
Desarrollo colectivo



Author: mwa0000023124537

Access: Private

Private View

Public View

Channel Settings

Sharing

API Keys

Data Import / Export

+ Add Visualizations

+ Add Widgets

Export recent data

MATLAB Analysis

MATLAB Visualization

## Channel Stats

Created: [3 months ago](#)

Last entry: [a day ago](#)

ThingSpeak™

Channels ▾

Apps ▾

Devices ▾

Support ▾

Commercial Use

How to Buy

NC

Estación de Medición - Temperatura

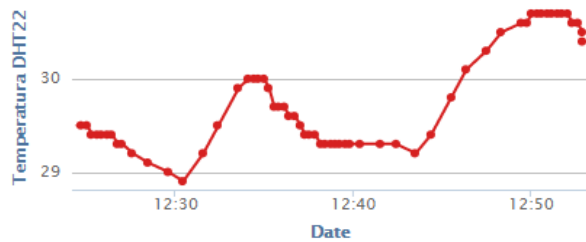

Temperatura DHT22



Estación de Medición - Humedad

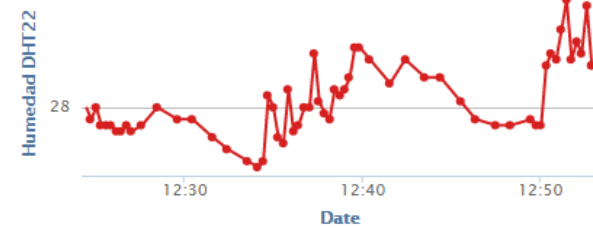

Humedad





	A	B	C
1	created_at	field1	field2
2			
3	2021-07-21 03:26:47 UTC	21.2	32.8
4	2021-07-21 03:27:55 UTC	21.2	32.6
5	2021-07-21 03:28:46 UTC	21	32.5
6	2021-07-21 03:29:54 UTC	21	32.7
7	2021-07-21 03:30:44 UTC	21.1	32.7
8	2021-07-21 03:31:52 UTC	21.2	32.5
9	2021-07-21 03:32:43 UTC	21.2	32.3
10	2021-07-21 03:33:51 UTC	21.6	31.7
11	2021-07-21 03:34:59 UTC	22.4	30.8
12	2021-07-21 03:35:52 UTC	22.6	30.4
13	2021-07-21 03:36:44 UTC	22.8	30.2
14	2021-07-21 03:37:52 UTC	23.1	29.8
15	2021-07-21 03:38:44 UTC	23.2	29.9
16	2021-07-21 03:39:01 UTC	23.2	29.9
17	2021-07-21 22:03:54 UTC	23.3	32.4
18	2021-07-21 22:04:44 UTC	23.4	31.4
19	2021-07-21 22:05:54 UTC	23.8	31.2
20	2021-07-21 22:06:44 UTC	24	31.2
21	2021-07-21 22:07:53 UTC	24.1	30.7

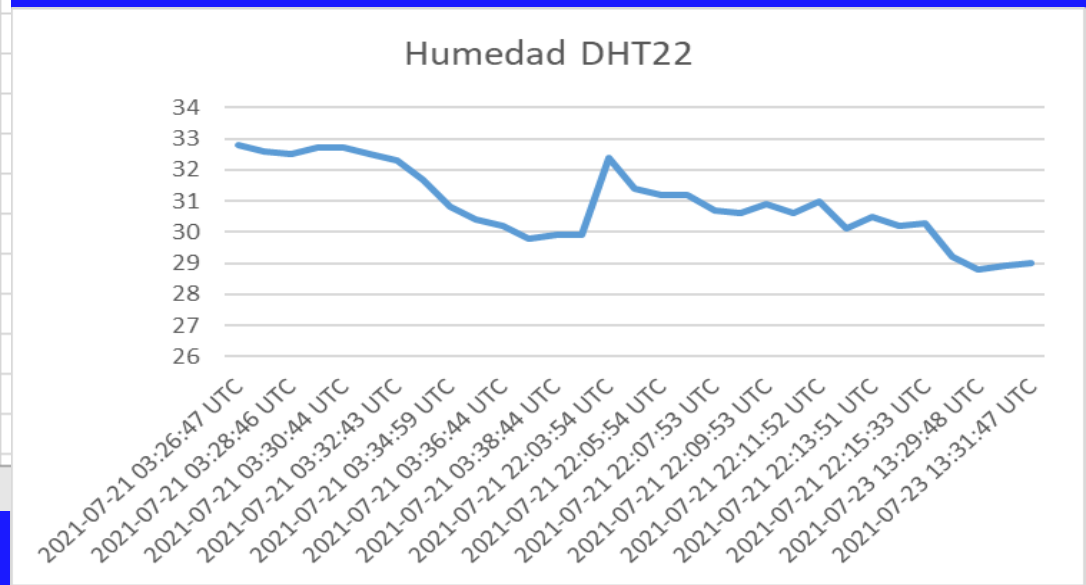
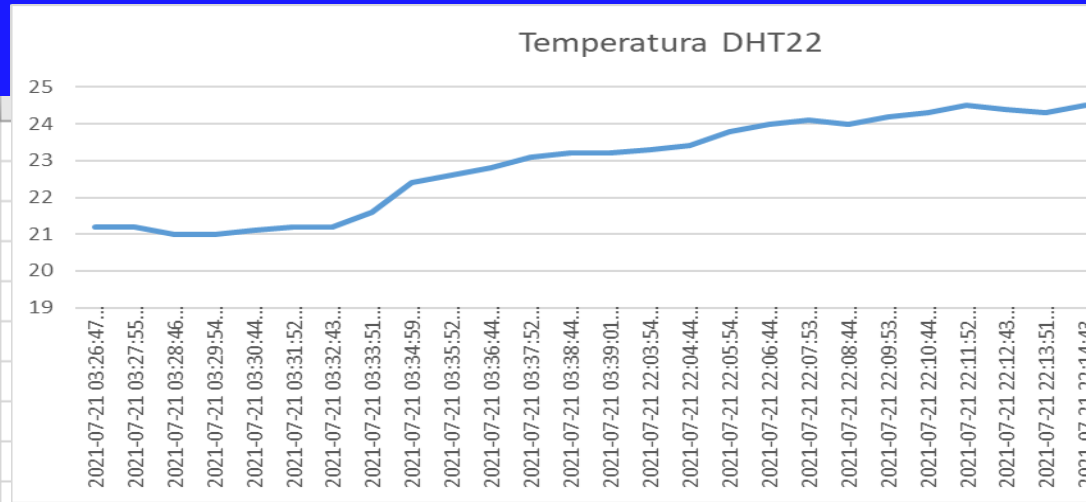

Aplicación desde  
el celular

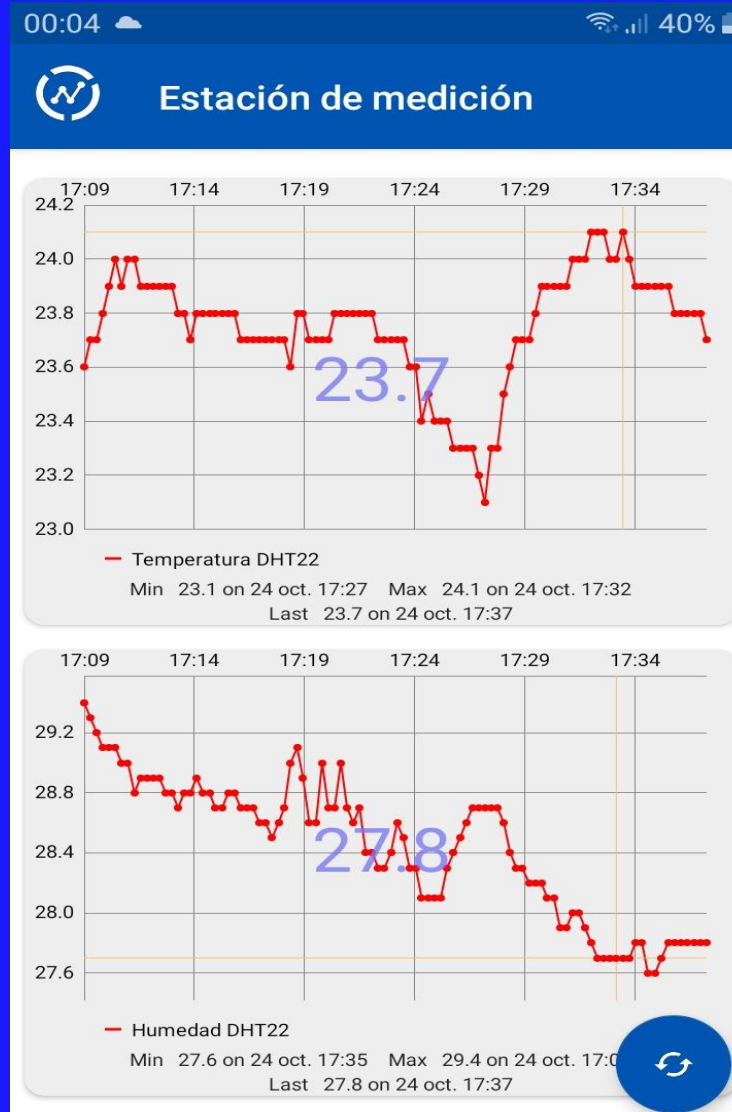

## Celular

## Notebook

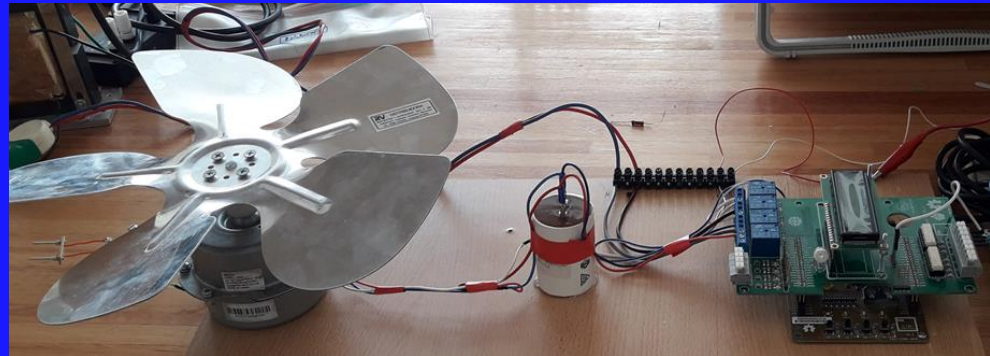
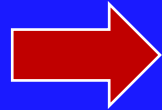
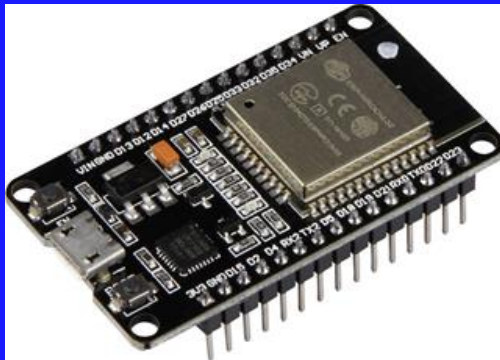
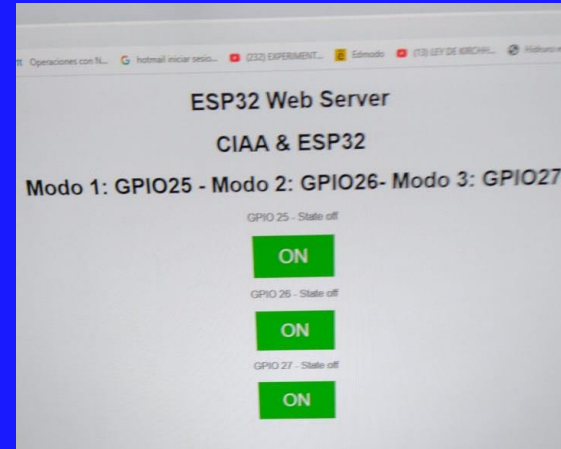
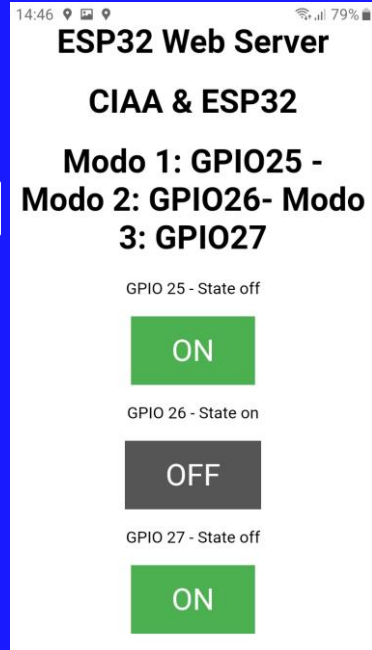
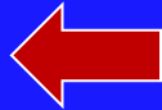



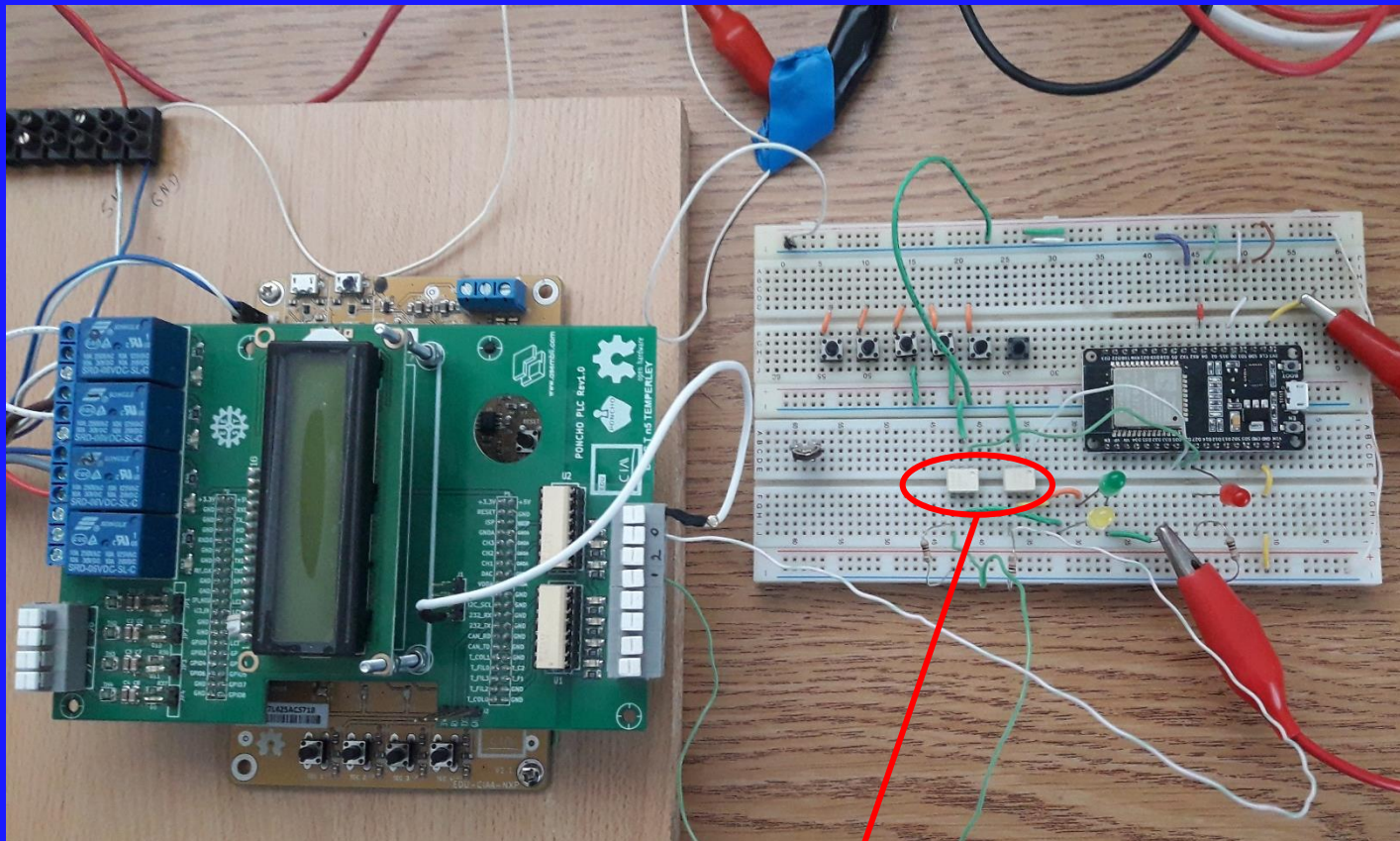

Optoacopladores

```

50 }
51 // Imprima la dirección IP y active el servidor |
52 Serial.println("");
53 Serial.println("WiFi connected.");
54 Serial.println("IP address: ");
55 Serial.println(WiFi.localIP());
56 server.begin();
57 }
58
59 void loop(){
60   WiFiClient client = server.available(); // Escucha a los cl
61
62   if (client) { // si se conecta un
63     currentTime = millis();
64     previousTime = currentTime;
65     Serial.println("New Client."); // escribe un mensa
66     String currentLine = ""; //Hace una cadena p
67     while (client.connected() && currentTime - previousTime <=
68           currentTime = millis();
69           if (client.available()) { // Si hay datos par
70             char c = client.read(); // lea un byte
71             Serial.write(c); // imprima en el mo
72             header += c;

```

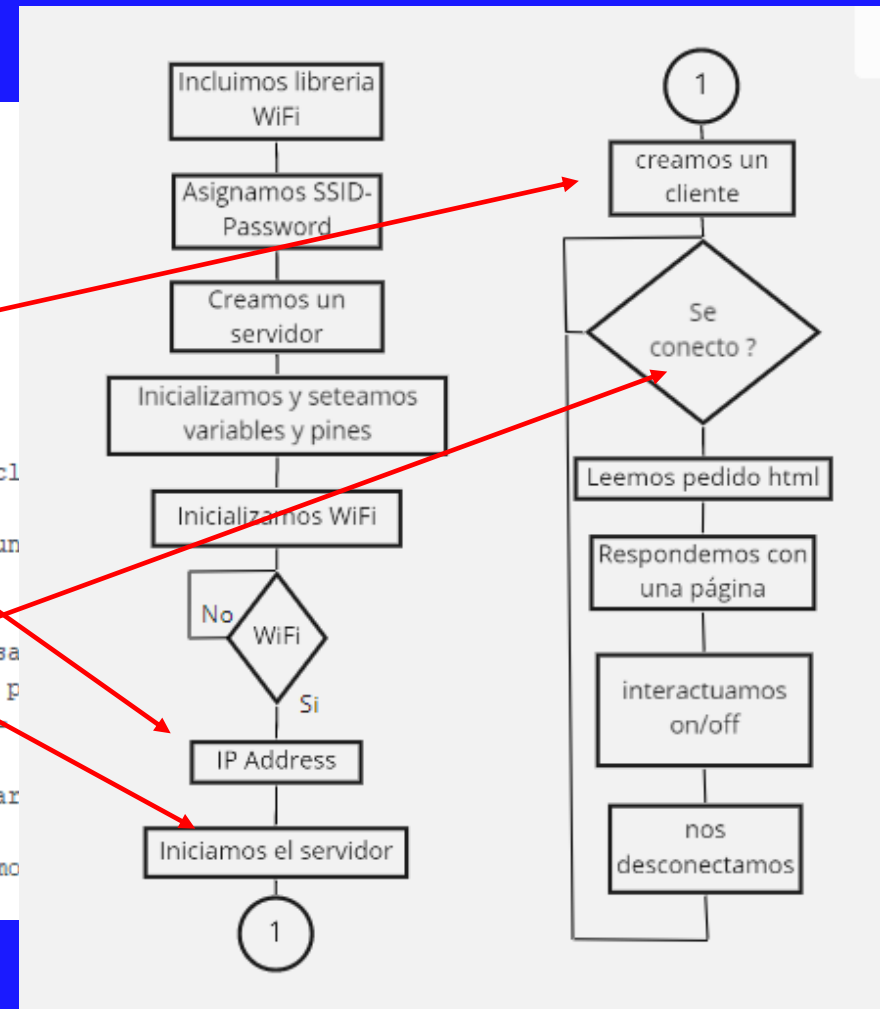

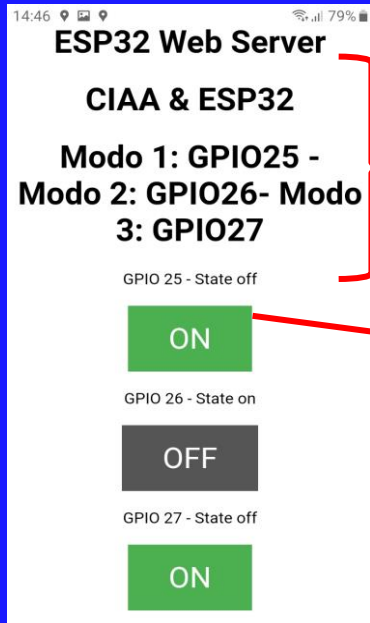

```

/ Mostrar la página web html
client.println("<!DOCTYPE html><html>");
client.println("<head><meta name=\"viewport\" content=\"width=device-width, initial-scale=1\">");
client.println("<link rel=\"icon\" href=\"data:,\">");

client.println("<style>html { font-family: Helvetica; display: inline-block; margin: 0px auto; text-align: ce
client.println(".button { background-color: #4CAF50; border: none; color: white; padding: 16px 40px;");
client.println("text-decoration: none; font-size: 30px; margin: 2px; cursor: pointer;});");
client.println(".button2 {background-color: #555555;}</style></head>");

// Cabecera de la página web
client.println("<body><h1>ESP32 Web Server</h1>");
client.println("<body><h1>CIAA & ESP32 </h1>"); //agregado el 22/7
client.println("<body><h1>Modo 1: GPIO25 - Modo 2: GPIO26- Modo 3: GPIO27 </h1>");//agregado 23/7

//Muestra el estado actual y los botones on/off del gpio 25
client.println("<p>GPIO 25 - State " + output25State + "</p>");
// Si el estado de 25 es off muestra el boton on
if (output25State=="off") {
  client.println("<p><a href=\"/25/on\"><button class=\"button\">ON</button></a></p>");
} else {
  client.println("<p><a href=\"/25/off\"><button class=\"button button2\">OFF</button></a></p>");
}

//Muestra el estado actual y los botones on/off del gpio 26
client.println("<p>GPIO 26 - State " + output26State + "</p>");
// muestra el estado actual y los botones on/off del gpio 26
if (output26State=="off") {

```

<https://www.youtube.com/watch?v=RAaM173FSd4>



SISTEMAS  
EMBEBIDOS  
2021



**Computadora Industrial  
Abierta Argentina**  
Desarrollo colectivo



# MUCHAS GRACIAS POR SU ATENCIÓN